

**Unobtainium Supply Co**  
When it's NLA, who do you call?



# K-Jetronic (CIS) Barb Insertion Tool Instructions

Rev. M  
Effective: 29-JUN-2023

**Unobtainium Supply Co.**  
523 Longley Rd  
Groton, MA 01450  
978.448.2110  
[www.UnobtainiumSupply.com](http://www.UnobtainiumSupply.com)

## **Contents**

K-Jetronic (CIS) BARB INSERTION TOOL INSTRUCTIONS .....	3
USING THE BARB INSERTION TOOL .....	3
8mm LINE BARB INSERTION .....	13
WOODEN BLOCK BARB INSERTION TOOL: .....	15

# K-Jetronic (CIS) BARB INSERTION TOOL INSTRUCTIONS

## ***USING THE BARB INSERTION TOOL***

These instructions apply to both the V1 maple barb insertion tool, and also the V2 plastic barb insertion tool.



It is suggested that you read this FerrariChat topic for the latest CIS fuel line restoration tips:

**Unobtainium Supplies: K-Jetronic (CIS) Plastic Fuel Line/Hose Restoration Kit**

<http://www.ferrarichat.com/forum/showthread.php?t=186689>

In addition to the tool, you will need:

- K-Jetronic (CIS) Plastic (or SS braid covered) Fuel Line/Hose Restoration Kit
- Heat Gun (think industrial strength hair dryer).
- Vise
- End Cutting pliers
- Tubing Flaring tool or wooden blocks(see below).

### NOTE:

The K-Jetronic (CIS) Plastic Fuel Line/Hose Restoration Kit (sold separately) contains sufficient lengths of the correct 5mm, 6mm, & 8mm black polyamide(aka: Nylon™) Cohline™, imported from Germany, to restore a Ferrari CIS system. There is enough extra line of each size to allow for several mistakes while learning how to insert the metal barbs into the line.

The following steps will guide you in restoring your fuel lines. They begin with removing the old fuel line and guide you thru using the tool to install the barbs into the new line:

1. Remove the old line.

**Make sure there is no fuel remaining in the old line.** Blowing it out with compressed air is the best way to ensure this. **This is important because the old fuel can ignite producing a mini-explosion & turning the tube into a mini flame-thrower!!!!**

Heat the old line with a hot air gun until it is very soft and can be pulled off of the barb by hand. Alternatively, a soldering iron can be used to melt a groove the length of the barb allowing the line to be pulled off.

Either of the above methods *avoid the risk of scratching the barb* when scoring the tubing as described in the BOSCH literature. It makes removal much easier and is a LOT FASTER than the scoring method!

If the old line won't soften enough to pull off, then heat the line till soft & use end cutting pliers to pinch the line off as shown in the following picture.



Be very careful to pinch only the line. A nicked barb will leak & must be replaced.



If absolutely necessary, you can loosen the line from around a barb by gently crushing it multiple times with pliers:



Then use the end cutting pliers as shown above.

2. Let the barb cool to room temperature before inserting it into the new line.
3. Separate the bottom section of the tool from the top. The pieces are shown in this picture:

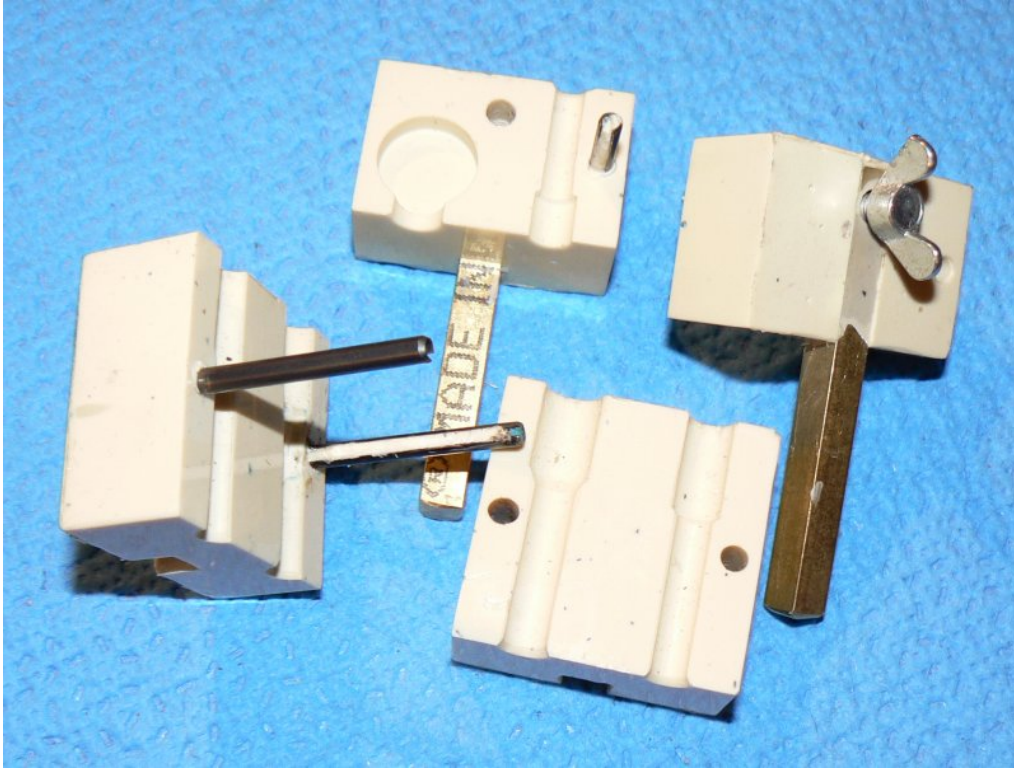

The following illustration shows the insertion tool's two bottom halves. The groove's lower smaller width section clamps the line and the wider upper section provides room for the barb to expand the line. The tool can handle both the 6mm & 5mm lines just by switching sides. The top section will properly align the barb with either of the bottom grooves.

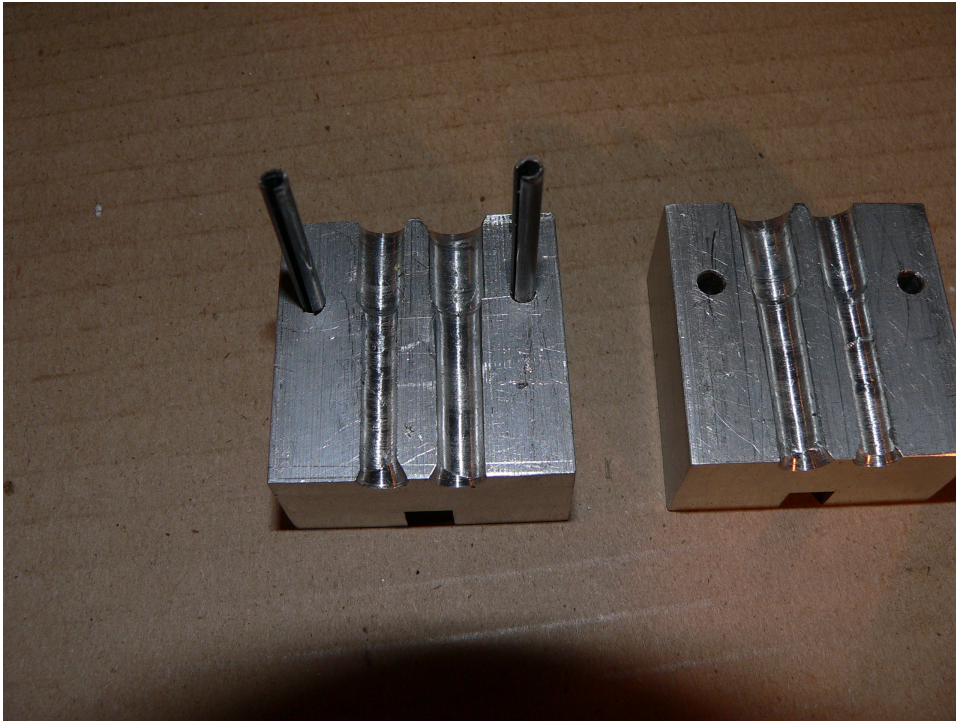

4. Insert the line's end into one side of the bottom section. The line should extend slightly above upper edge. Next slide the other half over the pins and clamp the tool's bottom section in a vice. The round alignment pins will keep the tool from sliding down thru the vice jaws.

The vice jaws both clamp the line in the bottom half, and also provide the outer edges of rectangular guides for the top section's square alignment keys. The square keys ensure the barb is kept vertical & goes straight into the tube.

**CAUTION: Do not heat up the line, it is not needed for barb insertion. Also, heated line can be permanently expanded enough by the barb's ridges so that it may not seal around the barb.**



5. Loosen the top section thumb screw loose enough so that gap between the halves is wide enough to insert the tubing barb or banjo fitting.
6. Insert the tubing barb (or banjo fitting) between the halves of the top section.
7. The two top section halves can be left as a sliding fit on the line and barb so it's easy to work with. While the picture shows the top section separated, In practice just leave the top section thumb screw loose enough so that the top will just slide open wide enough to insert the tubing barb or banjo fitting in the gap between the top pieces.

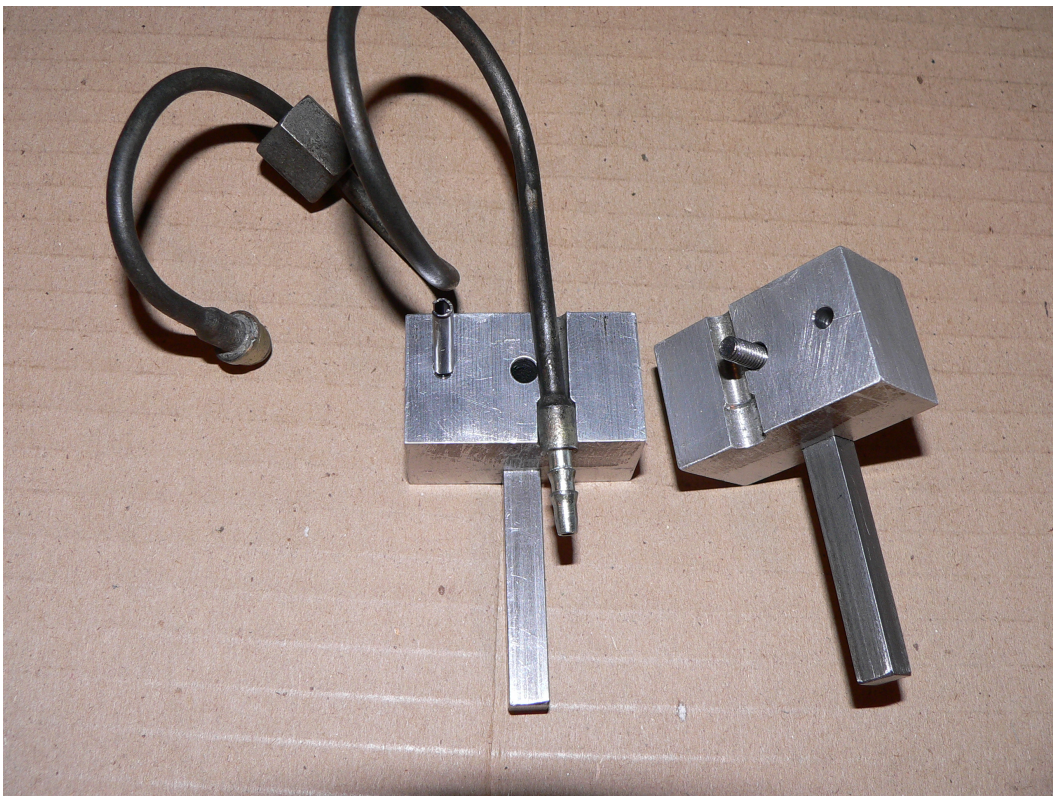

8. Squeeze the two halves of the top section together, clamping the barb or banjo between them. Then slip the alignment pins into the square grooves along the bottom section. The vice jaws holding the bottom half will also hold the top section together by the square alignment pins.

9. Press the top section downward, inserting the barb into the fuel line:

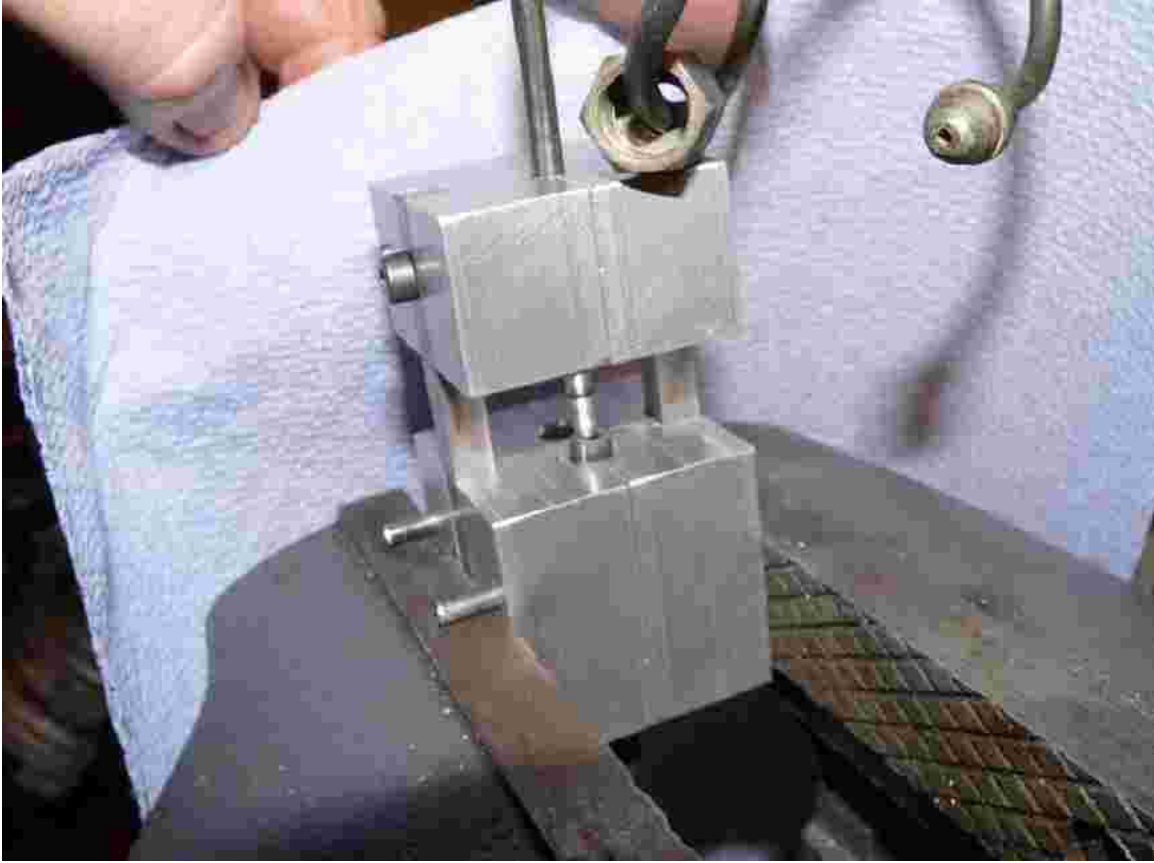

The preceding picture is a side view just before insertion. The square alignment grooves in the bottom section along with the vice jaws guide the top sections alignment pins to ensure the barb is exactly aligned with the fuel line.

Note that in this picture the tubing is slightly off-center in the clearance hole relative to the barb's end.

This is a side view just after beginning insertion using finger pressure. Note that the barb has brought the tubing back to center!

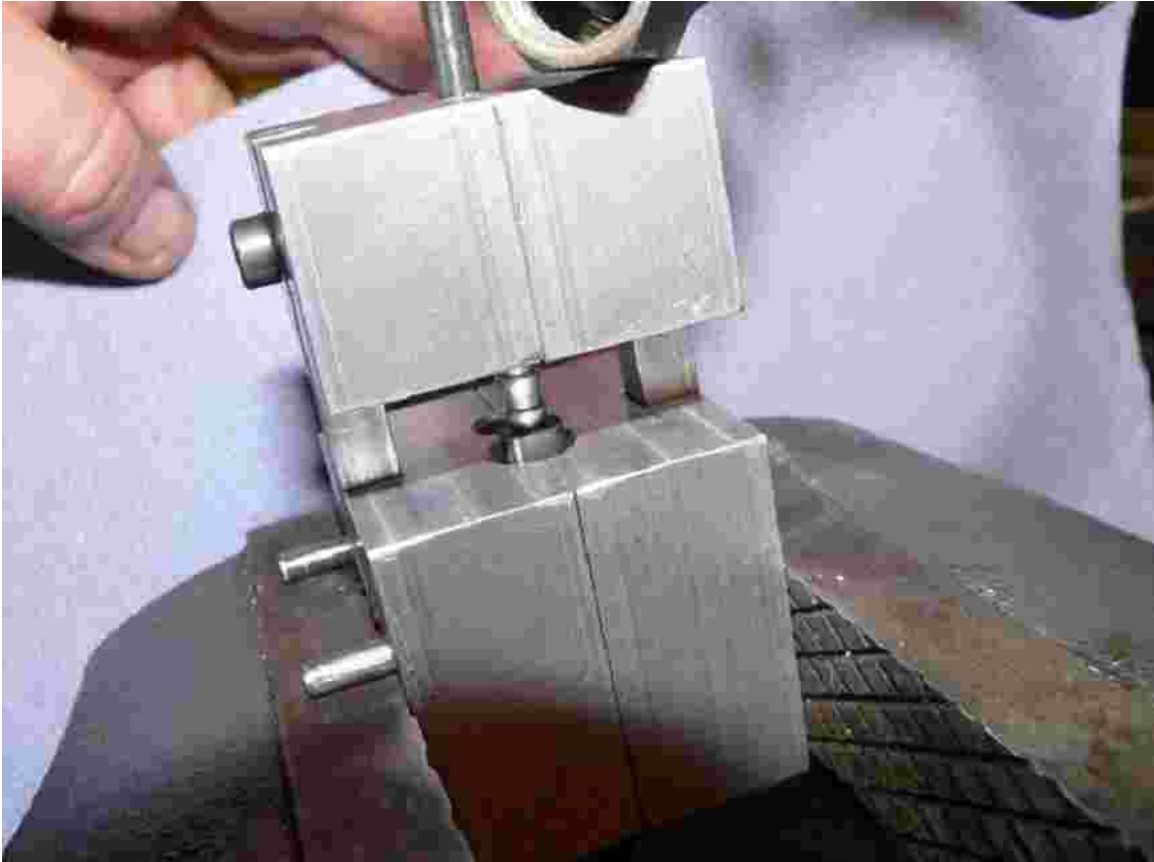

The following picture shows the tool in its closed position, the barb is fully inserted.

The barb can usually be fully inserted into 5mm line by pushing down with both thumbs on the tool's top. The barb can usually be fully seated into 6mm tubing by hand, but it sometimes takes a gentle tap or 2 with a rubber mallet on the tool's top of the to ensure it's fully seated. ***Use caution when tapping the tool with a mallet. The plastic the tool is made from can break from the shock of a sharp impact.***

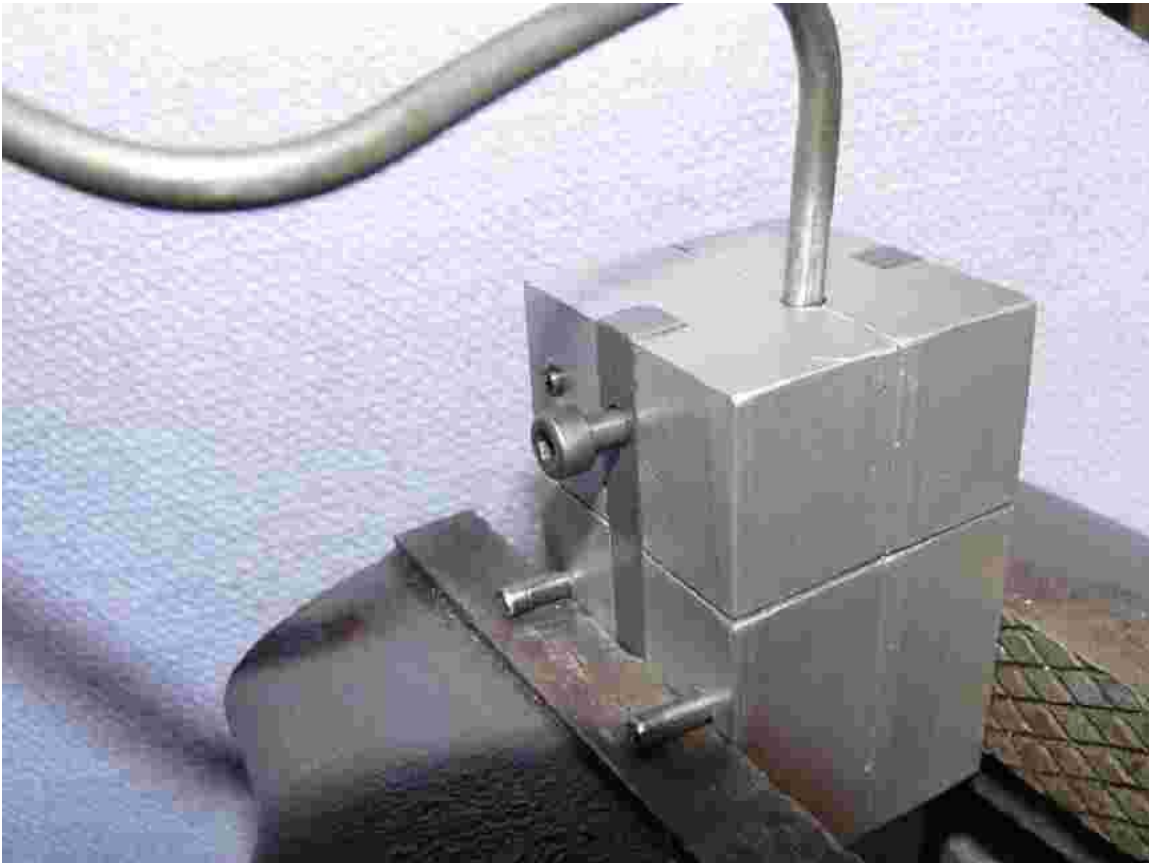

Note that in the above picture the set screw isn't fully tight. The setscrew doesn't need to be tight as the square alignment pins and vice jaws will hold the top closed. The screw is just loose enough for the barbed line or banjo to slip in & out between the halves. This can speed up operation considerably!

**NOTE:**

The large banjo on top of the fuel distributor will not fit into the tool's upper half. Use this alternate procedure to install the oversize barb:

1. Clamp the new line in the bottom half as previously described.

2. Hold the large banjo place with your fingers with it's barb pointing straight down into the line's opening. Alternatively, use a piece of wooden dowel, or other cylindrical object thru the banjo's center hole to hold the banjo.
3. Tap on the banjo's top with a rubber hammer to drive its barb into the new line.



## 8mm LINE BARB INSERTION

The CIS barb insertion tool is not needed to insert barbs into 8mm line.

Instead, you wrap the area to be clamped with 3 layers of masking tape to protect the line. Use the clamping part of a tubing flaring tool, or make a wooden block tool (see below) clamped into a vise to hold the new 8mm line while using a plastic hammer to tap the banjo's barb into the line.

TIPS for SS Braid covered line:

- To cut the line: wrap the area to be cut with 3 layers of masking tape, then use a Dremel™ tool with an abrasive cut-off wheel to cut the line thru the wrapped tape, rotating the line as you cut.

The wheel will leave a ridge of melted plastic on the inside of the cut off inner plastic tubing. Use an eXacto or similar sharp knife to cut off the ridge and leave the tubing with a slightly tapered end.

Then remove the masking tape.

- Barb insertion: Slip the metal sleeve onto the end of the line, then wrap 3 to 4 layers of masking tape around the braided line immediately below the sleeve. Insert the line into the clamping tool with the sleeve resting on the top edge of the tool. The tool will grip the wrapped tape. It is very important to:
  1. Verify the line is fully inserted into the sleeve.
  2. Make sure that the plastic line is firmly clamped, otherwise the barb might be partially inserted, resulting in a fuel leak. If possible leak test the line with 90psi compressed air before installing it.
- The sleeve does not require crimping. When the barb is inserted, it expands the plastic line. The expanded plastic line clamps the SS braid firmly outward against the metal sleeve.

FLARING TOOL:

Use the tubing clamp part of a basic flaring tool set, available at most hardware stores. Also often found in the bargain tool bin at auto parts stores:



Use the 5/16"(7.94 mm) hole, it should grip fine on either the 8mm plastic or SS braided line. Only tighten the wing nuts enough to hold the line while inserting the barb. Once you get the line gripped by the tool, lay the tool between vise jaws that grip it & let the wing nuts keep the tool from going thru the vise jaws while tapping the barb into the fuel line.

## WOODEN BLOCK BARB INSERTION TOOL:

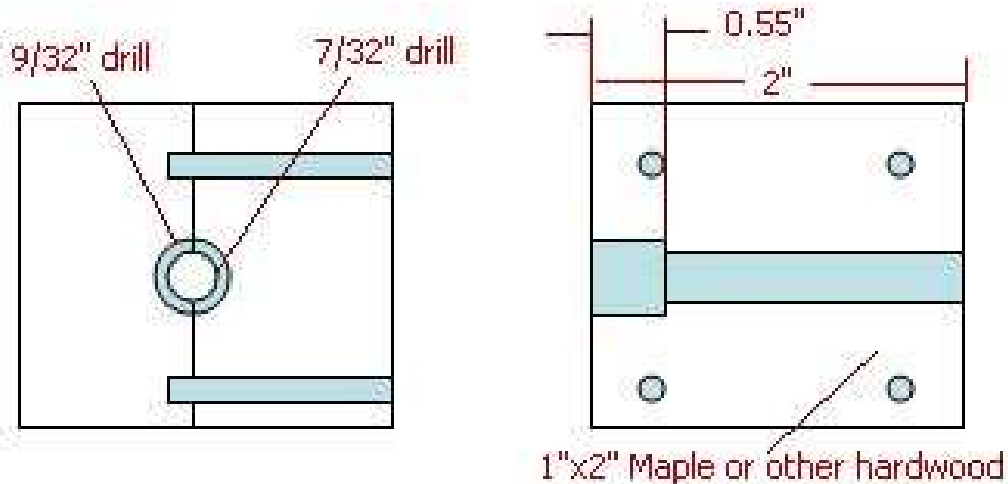

This block drawing was posted by echrisconner in one of the Porsche CIS threads. It is just a variant of the barb insertion tool's bottom half & works the same way. In fact, it was the inspiration for the barb insertion tool.

To make one take 2 2" long 1x2 wooden blocks, clamp them together with a piece of cardboard or thin wood about 1/16"-3/32" thick between them, then drill a 7/32" hole thru the blocks. Next drill the 9/32" hole. Removing the cardboard separator results in the the blocks having slightly less than 1/2 of the hole in each block. The partial half-holes will clamp the line firmly, when snugged together in a vise. Like the barb insertion tool, the larger hole segment is needed to ensure there's room for the barb to expand the line.

Chris's version uses 4 pins to align the 2 halves. 4 is overkill, 2 is plenty. In fact, If you're just doing a couple of lines, don't bother with the alignment pins. The line itself will hold the 2 blocks in alignment.

If you want alignment pins, clamp the 2 blocks together again, drill the alignment pin holes thru one wooden block & 1/2 ways into the 2<sup>nd</sup> block. The drill size should produce a tight press fit. Press the pins into the block with partial thru-holes. Then use a drill size that lets the pin slide freely & drill the 2 thru-holes in the other block oversize.

**Unobtainium Supply Co.**  
523 Longley Rd.  
Groton, MA  
01450  
[www.UnobtainiumSupply.com](http://www.UnobtainiumSupply.com)